





Pure Sound 22

STEREO DIGITAL ECHO KARAOKE AMPLIFIER



- Infrared Remote Control
- 9 Steps Digital Key Control
- 5 Microphones Jack (3Front/2Rear) For Usage
- Overload And Short Protecting Circuit
- Dual Voltage (110v/220v) For Select
- Innovative Digital Echo Effect & Echo Tone Adjustment

SAFETY INSTRUCTIONS

	CAUTION RISK OF ELECTRIC SHOCK, DO NOT OPEN!	
CAUTION: TO REDUCE THE RISK OF ELECTRIC SHOCK, DO NOT REMOVE COVER (OR BACK). NO USER-SERVICEABLE PARTS INSIDE. REFER SERVICING TO QUALIFIED SERVICE PERSONNEL.		

Explanation of Graphical Symbols



The lightning flash with arrowhead symbol, within an equilateral triangle, is intended to alert you to the presence of uninsulated "dangerous voltage" within the product's enclosure that may be of sufficient magnitude to constitute a risk of electric shock to persons.



The exclamation point within an equilateral triangle is intended to alert you to the presence of important operating and maintenance (servicing) instructions in the literature accompanying the appliance.

WARNING:

TO REDUCE THE RISK OF FIRE OR ELECTRIC SHOCK,
DO NOT EXPOSE THIS UNIT TO RAIN OR MOISTURE.

- 1 Read instructions- All the safety and operating instructions should be read before the unit is operated.
- 2 Retain Instructions - The safety and operating instructions should be retained for future reference.
- 3 Heed Warnings-All warnings on the units and in the operating instructions should be adhered to.
- 4 Follow Instructions - All operations and other instructions should be followed.
- 5 Water and Moisture- The unit should not be used near water- for example, near a bathtub, washbowl, kitchen sink, laundry tub, in a wet basement, or near a swimming pool, etc.
- 6 Carts and Stands - The unit should be used only with a cart or stand that is recommended by the manufacturer.
- 6A A unit and cart combination should be moved with care. Quick stops, excessive force, and uneven surfaces may cause the unit and cart combination to overturn. 
- 7 Grounding or Polarization- Precautions should be taken so that the grounding or polarization is not defeated.
- 8 Ventilation - The unit should be situated so that its location or position does not interfere with its proper ventilation. For example, the unit should not be situated on a bed, sofa, rug, or similar surface, that may block the ventilation openings; or placed in a built-in installation, such as a bookcase or cabinet that may impede the flow of air through the ventilation openings.
- 9 Heat- The unit should be situated away from heat sources such as radiators, stoves, or other appliances that produces heat.
- 10 Power Sources - The unit should be connected to a power supply only of the type described in the operating instructions or as marked on the unit.
- 11 Power Cord Protection - Power supply cords should be routed so that they are not likely to be walked on or pinched by items placed upon or against them, paying particular attention to cords at plugs, convenience receptacles, and the point where they exit the unit.
- 12 Cleaning- The unit should be cleaned only as recommended by the manufacturer.
- 13 Nonuse Periods- The power cord of the unit should be unplugged from the outlet when left unused for a long period of time.
- 14 Object and liquid Entry- Care should be taken so that objects do not fall into and liquids are not spilled into the inside of the unit.
- 15 Damage Requiring Service - The unit should be serviced by qualified service personnel when:
 - A. The power supply cord or the plug has been damaged; or
 - B. Objects have fallen, or liquid has been spilled into the unit; or
 - C. The unit has been exposed to rain; or
 - D. The unit does not appear to operate normally or exhibits a marked change in performance.
 - E. The unit has been dropped, or the cabinet damaged.
- 16 Servicing - The user should not attempt to service the unit beyond those means described in the operating instructions. All other servicing should be referred to qualified service personnel.
- 17 Power Lines - An outdoor antenna should be located away from power lines.
- 18 Grounding or Polarization - Precautions should be taken so that the grounding or polarization is not defeated.

<p>IMPORTANT</p> <p>please record the serial number of this unit in the space below.</p> <p>Model: Serial No.:</p> <p>The serial number is located on the rear of the unit. Retain this Owner's Manual in a safe place for future reference.</p>

1. OPERATING GUIDE

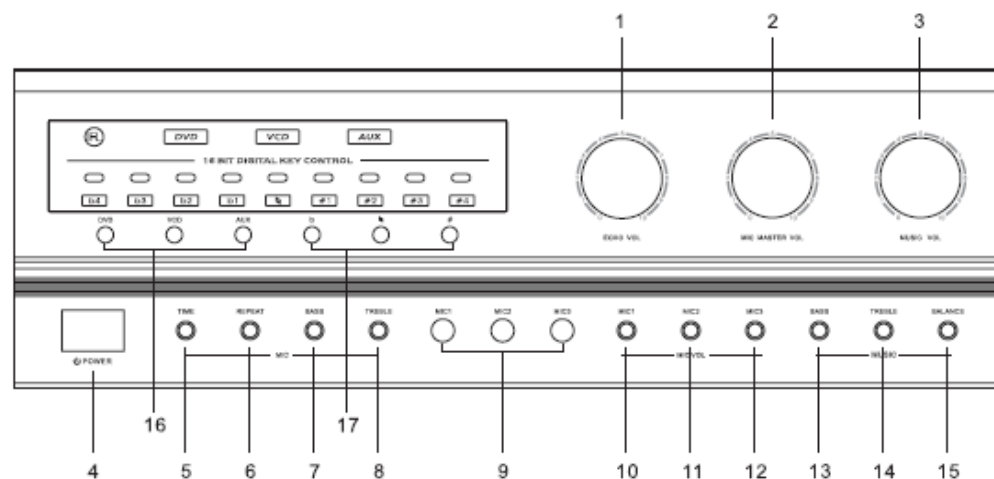

1. ECHO VOLUME CONTROL

Controls the echo level of the microphone's echo effect.

2. MICROPHONE MASTER VOLUME CONTROL

Adjust to increase or decrease the volume of the 3 separate microphones.

3. MUSIC VOLUME CONTROL

Controls the music level of all audio channels.

4. POWER ON-OFF SWITCH

Press the button to turn the main unit on or off.

5. MICROPHONE ECHO TIME CONTROL

Adjust to control the echo time of the microphone.

6. MICROPHONE ECHO REPEAT CONTROL

Adjust to control the echo repeat of the microphone.

7. MICROPHONE BASS TONE CONTROL

Adjust to strengthen or weaken the bass response of microphones according to singer's tone quality.

8. MICROPHONE TREBLE TONE CONTROL

Adjust to strengthen or weaken the treble response of the microphone according to singer's tone quality.

9. MICROPHONE INPUT JACK

Plug-in the 3 separate microphones for usage.

10. MICROPHONE(1) VOLUME CONTROL

Adjust to increase or decrease the volume of the microphone(1).

11. MICROPHONE(2) VOLUME CONTROL

Adjust to increase or decrease the volume of the microphone(2).

12. MICROPHONE(3) VOLUME CONTROL

Adjust to increase or decrease the volume of the microphone(3).

13. MUSIC BASS CONTROL

Adjust to strengthen or weaken music bass response.

14. MUSIC TREBLE CONTROL

Adjust to strengthen or weaken music treble response.

15. BALANCE CONTROL

Use the balance control knob to adjust the relative volume levels of the right and left Main speaker system.

16. INPUT SIGNAL SELECTOR

Selects the source connected to the input jacks.

17. KEY CONTROL

Adjust to select the music's key according to the singer's key.

2.FUNCTION OF REAR PANEL

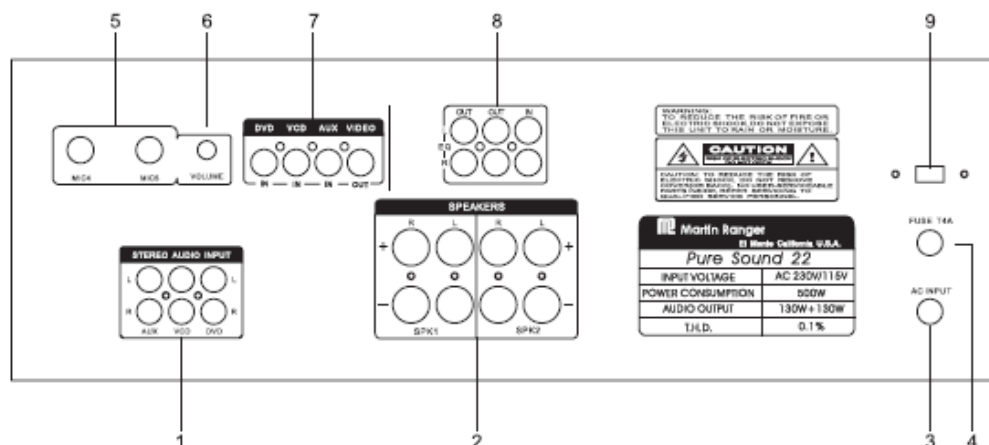

1. STEREO AUDIO INPUT

The terminal use to connect sound source, such as DVD VCD AUX.

2. SPEAKER SYSTEMS TERMINAL

Do not let the bare speaker wires touch each other or any other metal part as this could damage this unit and/or speakers. Make sure that the polarity of the speaker wires is correct, that is: + and - marking are observed. If these wires are reversed, the sound will be unnatural and will lack bass. When one speaker system is used, speakers with an impedance of 4 to 8 ohms should be connected for used as main amplifier output terminals. Be careful when using two pairs of front or center speaker at the same time. since use of speakers with an impedance of less than 8 ohms will lead to damage, should use speakers with an impedance of 8 ohms to 16 ohms.

3. AC POWER SUPPLY

Before plug-in the power supply, be sure to use the voltage of 230V 50Hz./115V 60HZ(±10%)

4. AC POWER FUSE HOLDER

Use T4A fuse.

5. MICROPHONE(4/5) JACK

Plug-In the rear microphone JACK for usage.

6. MICROPHONE(4/5) VOLUME

Adjust to increase or decrease the volume of the microphones(4)and(5).

7. VIDEO INPUT/OUT JACKS

Connect input jack with the video output of DVD VCD/Video tape or CDG etc. And connect output jack with the video input of the monitor TV.

8. SOUND-EFFECT DEVICE INPUT/OUTPUT TERMINAL

The terminal use to connect external sound-effect devices such as Equalizer/Power Amplifier.

9. DUAL VOLTAGE SELECTOR

For AC230V/110V Voltage select.

Function of Remote Controller

1. Key control
2. Input selector
3. Microphone volume control
4. Music volume control

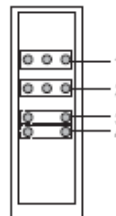

3.CONNECTING GUIDE

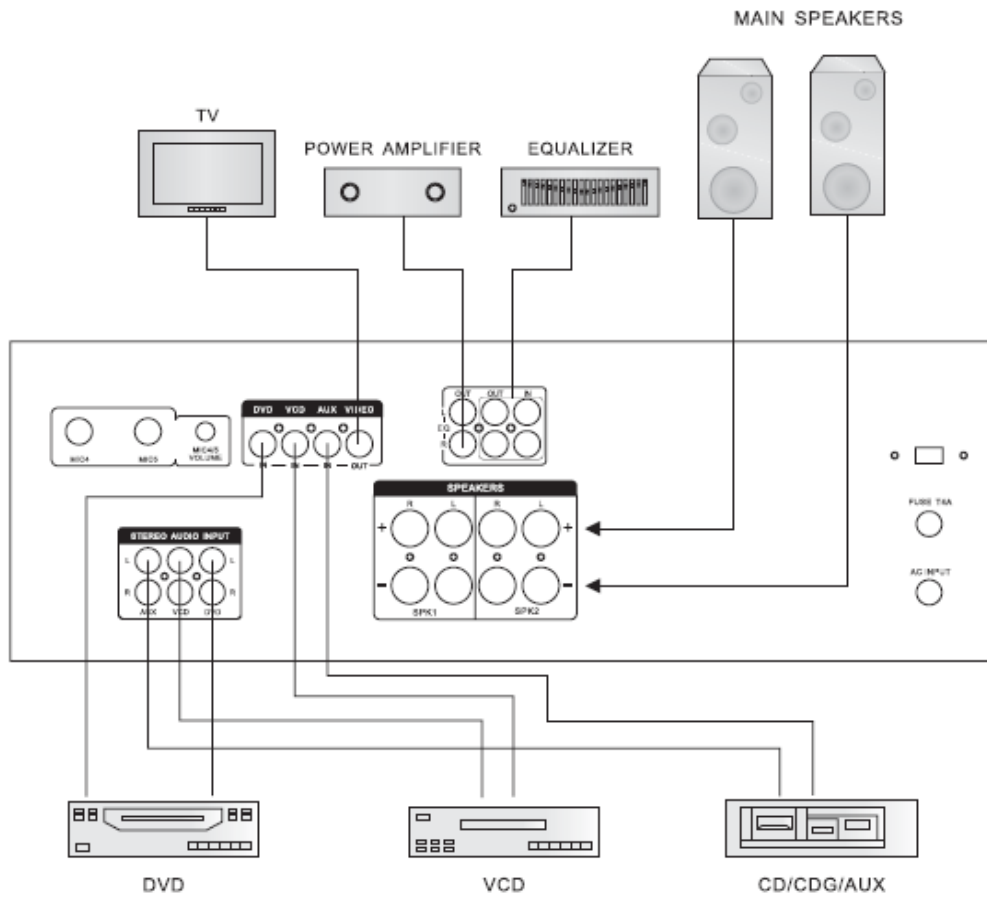

NOTE:

When using 2 speaker systems, the impedance should not be lower than 8 ohms for each system, otherwise the unit may be damaged under high power and long term operation.







OPERATION MANUAL

4. SPECIFICATIONS

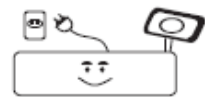
Audio output max	130W+130W
Mic input sensitivity	10mV
External devices sensitivity	200mV
Signal / Noise ratio (with IHF A Filter)	80dB
T.H.D. (1 kHz. AUX 150mV INPUT)	0.1%
Frequency Response	25Hz~20KHz
Music. Tone adjustment	80Hz±15dB
	12KHz±15dB
Echo tone adjustment	100Hz±10dB
	10KHz±10dB
Power source	AC 110V/60Hz AC 230V/50Hz
Electricity consumption	500W
Net Weight	8.8 KGS
Dimension (mm)	430(W)X140(H)X355(D)

* Specifications and features are subject to changed without notice.

5. SAFETY GUIDE

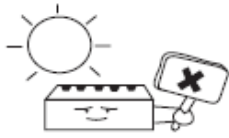
<p>Be careful when open, otherwise electric shock or serious damage may be made to the product.</p> 	<p>Unplug this product from the wall outlet when not use for a long period of time</p> 	<p>Unplug this product from the wall outlet during lightning</p> 
<p>Objects do not fall into the enclosure.</p> 	<p>Arrange power cords safely. Do not hold the cord when pulling out from the wall outlet. Pull out holding plug.</p> 	<p>This product must not touch chemicals such as benzene, thinner or alcohol. This may result in discoloration.</p> 
<p>Do not use this product in wet place.</p> 	<p>This product should be installed in well-ventilated and cool place.</p> 	<p>This product should be installed flatly and should not be shaken.</p> 